

NEC

User's Manual

IE-703040-MC-EM1

In-circuit Emulator Option Board

Target device
V850/SV1™

Document No. U14337EJ1V0UM00 (1st edition)
Date Published August 1999 N CP(K)

© NEC Corporation 1999
Printed in Japan

[MEMO]

V850 Family and V850/SV1 are trademarks of NEC Corporation.

Windows is either a trademark or a registered trademark of Microsoft Corporation in the United States and/or other countries.

PC/AT is a trademark of International Business Machines Corporation.

Ethernet is a trademark of Xerox Corporation.

UNIX is a registered trademark in the United States and other countries, licensed exclusively through X/Open Company Limited.

- **The information in this document is subject to change without notice. Before using this document, please confirm that this is the latest version.**
- No part of this document may be copied or reproduced in any form or by any means without the prior written consent of NEC Corporation. NEC Corporation assumes no responsibility for any errors which may appear in this document.
- NEC Corporation does not assume any liability for infringement of patents, copyrights or other intellectual property rights of third parties by or arising from use of a device described herein or any other liability arising from use of such device. No license, either express, implied or otherwise, is granted under any patents, copyrights or other intellectual property rights of NEC Corporation or of others.
- Descriptions of circuits, software, and other related information in this document are provided for illustrative purposes in semiconductor product operation and application examples. The incorporation of these circuits, software, and information in the design of the customer's equipment shall be done under the full responsibility of the customer. NEC Corporation assumes no responsibility for any losses incurred by the customer or third parties arising from the use of these circuits, software, and information.

M7A 98.8

Regional Information

Some information contained in this document may vary from country to country. Before using any NEC product in your application, please contact the NEC office in your country to obtain a list of authorized representatives and distributors. They will verify:

- Device availability
- Ordering information
- Product release schedule
- Availability of related technical literature
- Development environment specifications (for example, specifications for third-party tools and components, host computers, power plugs, AC supply voltages, and so forth)
- Network requirements

In addition, trademarks, registered trademarks, export restrictions, and other legal issues may also vary from country to country.

NEC Electronics Inc. (U.S.)

Santa Clara, California
Tel: 408-588-6000
800-366-9782
Fax: 408-588-6130
800-729-9288

NEC Electronics (Germany) GmbH

Duesseldorf, Germany
Tel: 0211-65 03 02
Fax: 0211-65 03 490

NEC Electronics (UK) Ltd.

Milton Keynes, UK
Tel: 01908-691-133
Fax: 01908-670-290

NEC Electronics Italiana s.r.l.

Milano, Italy
Tel: 02-66 75 41
Fax: 02-66 75 42 99

NEC Electronics (Germany) GmbH

Benelux Office
Eindhoven, The Netherlands
Tel: 040-2445845
Fax: 040-2444580

NEC Electronics (France) S.A.

Velizy-Villacoublay, France
Tel: 01-30-67 58 00
Fax: 01-30-67 58 99

NEC Electronics (France) S.A.

Spain Office
Madrid, Spain
Tel: 91-504-2787
Fax: 91-504-2860

NEC Electronics (Germany) GmbH

Scandinavia Office
Taebby, Sweden
Tel: 08-63 80 820
Fax: 08-63 80 388

NEC Electronics Hong Kong Ltd.

Hong Kong
Tel: 2886-9318
Fax: 2886-9022/9044

NEC Electronics Hong Kong Ltd.

Seoul Branch
Seoul, Korea
Tel: 02-528-0303
Fax: 02-528-4411

NEC Electronics Singapore Pte. Ltd.

United Square, Singapore 1130
Tel: 65-253-8311
Fax: 65-250-3583

NEC Electronics Taiwan Ltd.

Taipei, Taiwan
Tel: 02-2719-2377
Fax: 02-2719-5951

NEC do Brasil S.A.

Electron Devices Division
Rodovia Presidente Dutra, Km 214
07210-902-Guarulhos-SP Brasil
Tel: 55-11-6465-6810
Fax: 55-11-6465-6829

J99.1

INTRODUCTION

Target Readers This manual is intended for users who design and develop application systems using the V850/SV1™.

Purpose The purpose of this manual is to describe the proper operation of the IE-703040-MC-EM1 and its basic specifications.

Organization This manual is divided into the following parts.

- Overview
- Names and functions of components
- Cautions

How to Read This Manual It is assumed that the reader of this manual has general knowledge in the fields of electrical engineering, logic circuits, and microcontrollers. The IE-703040-MC-EM1 is used connected to the IE-703002-MC in-circuit emulator. This manual explains the basic setup procedure and switch settings of the IE-703002-MC when it is connected to the IE-703040-MC-EM1. For the names and functions of parts, and the connection of elements, refer to the **IE-703002-MC User's Manual (U11595E)**.

To learn about the basic specifications and operation methods
→ Read this manual in the order of the **CONTENTS**.

To learn the operation methods and command functions, etc., of the IE-703002-MC and IE-703040-MC-EM1
→ Read the user's manual of the debugger (sold separately) that is used.

Conventions

Note: Footnote for item marked with **Note** in the text

Caution: Information requiring particular attention

Remark: Supplementary information

Numeral representation: Binary ... xxxx or xxxxB
Decimal ... xxxx
Hexadecimal ... xxxxH

Prefix indicating the power of 2 (address space, memory capacity):
K (kilo): $2^{10} = 1024$
M (mega): $2^{20} = 1024^2$

Terminology The meanings of terms used in this manual are listed below.

Target device	The device that is targeted for emulation.
Target system	The system (user-built system) that is targeted for debugging. This includes the target program and user-configured hardware.

Related Documents

When using this manual, refer to the following manuals.

The related documents indicated in this publication may include preliminary versions. However, preliminary versions are not marked as such.

○ Documents related to development tools (user's manuals)

Document Name		Document Number
IE-703002-MC		U11595E
IE-703040-MC-EM1		This manual
CA830, CA850 (C Compiler package)	Operation Windows-based	U13998E
	C language	U13997E
	Project manager	U13996E
CA850 (C Compiler package)	Assembly Language	U13828E
ID850 (Ver.1.31) (Integrated debugger)	Operation Windows-based	U13716E
ID850 (Ver.2.00 or more) (Integrated debugger)	Operation Windows-based	U14217E
SM850 (Ver.2.00 or more) (System simulator)	Operation Windows-based	U13759E
RX850 (Real-time OS)	Basics	U13430E
	Installation	U13410E
RX850 Pro (Real-time OS)	Fundamental	U13773E
	Installation	U13774E
RD850 (Task debugger) ^{Note}	Windows-based	U11158E
RD850 (Ver.3.0) (Task debugger)	Windows-based	U13737E
RD850 Pro (Ver.3.0) (Task debugger)	Windows-based	U13916E
AZ850 (System performance analyzer)		U11181E

Note For ID850 (Ver. 1.31 only)

CONTENTS

CHAPTER 1 OVERVIEW	11
1.1 Hardware Configuration	11
1.2 Features (When Connected to IE-703002-MC)	12
1.3 Function Specifications (When Connected to IE-703002-MC).....	12
1.4 System Configuration	13
1.5 Contents in Carton	14
1.6 Connection between IE-703002-MC and IE-703040-MC-EM1	16
CHAPTER 2 NAMES AND FUNCTIONS OF COMPONENTS.....	19
2.1 Component Names and Functions of IE-703040-MC-EM1	19
2.2 Clock Settings.....	21
2.2.1 Main system clock setting	21
2.2.2 Subsystem clock setting.....	22
2.3 Illegal Access Detection ROM Setting	23
2.4 CPU Operation Voltage Range Switching Setting	23
CHAPTER 3 FACTORY SETTINGS	25
CHAPTER 4 CAUTIONS.....	27
4.1 V _{DD} and BV _{DD} of Target System	27
4.2 NMI Signal	28
4.3 V _{PP} Signal	28
4.4 NMI Signal Mask Function	29
4.5 Bus Interface Pin	29
APPENDIX PACKAGE DRAWINGS.....	31

LIST OF FIGURES

Figure No.	Title	Page
1-1	System Configuration	13
1-2	Contents in Carton.....	14
1-3	Accessories	15
1-4	Connection between IE-703002-MC and IE-703040-MC-EM1	17
2-1	IE-703040-MC-EM1	19
4-1	Schematic Diagram of Power Supply Acquisition.....	27
4-2	NMI Signal Flow Path	28
4-3	V _{PP} Signal Flow Path	28

LIST OF TABLES

Table No.	Title	Page
2-1	Main System Clock Setting	21
2-2	Subsystem Clock Setting	22
2-3	JP1 Setting in IE-703002-MC	23
2-4	JP3 and JP4 Setting in IE-703002-MC	23
4-1	Bus Interface Pin Operation List	29

[MEMO]

CHAPTER 1 OVERVIEW

The IE-703040-MC-EM1 is an option board for the IE-703002-MC in-circuit emulator. By connecting the IE-703040-MC-EM1 and IE-703002-MC, hardware and software can be debugged efficiently in system development using the V850/SV1.

In this manual, the basic setup procedure and switch settings of the IE-703002-MC when using the IE-703040-MC-EM1 are described. For the names and functions of the parts of the IE-703002-MC, and for the connection of elements, refer to the **IE-703002-MC User's Manual (U11595E)**.

1.1 Hardware Configuration

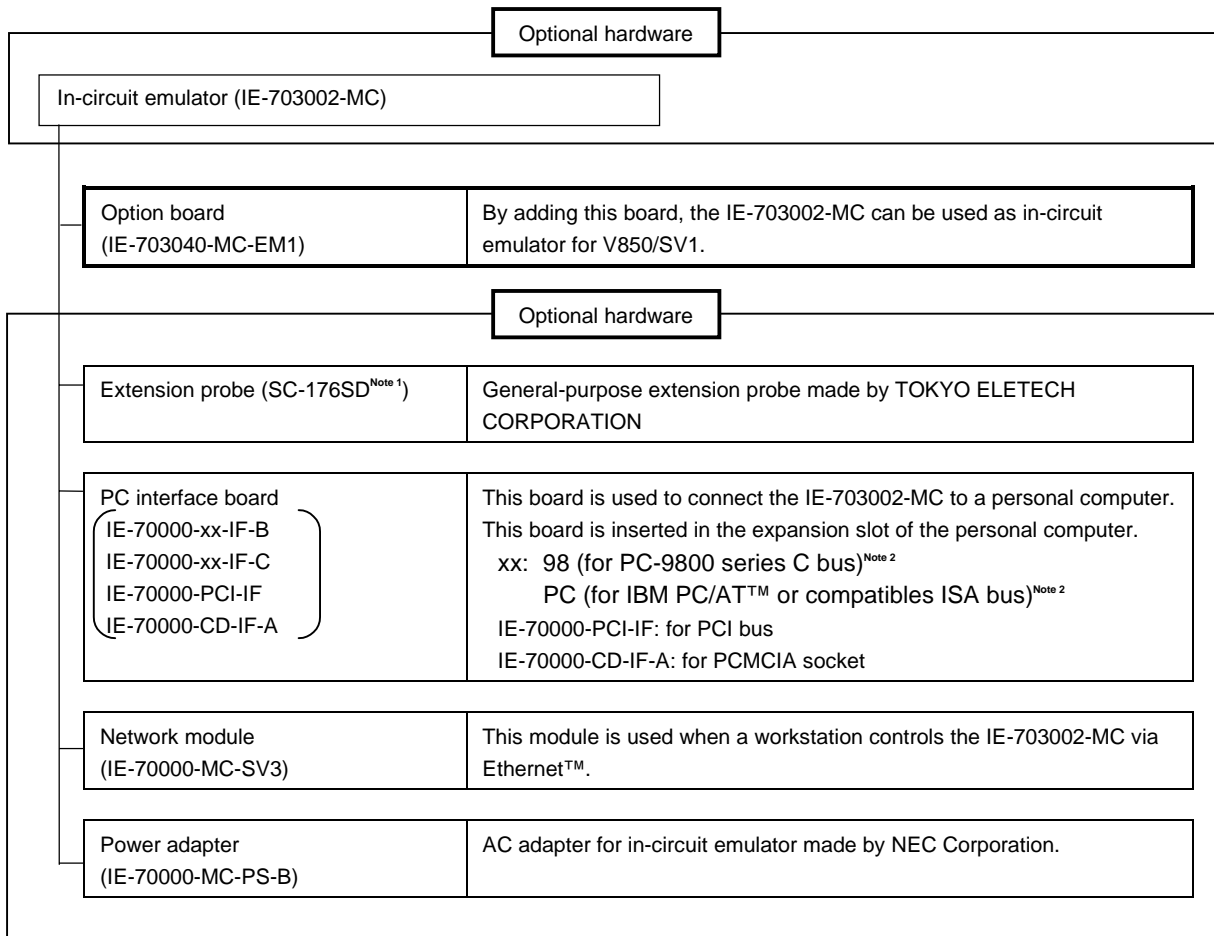

- Notes**
- For further information, contact Daimaru Kogyo Co., Ltd.
Tokyo Electronics Department (TEL +81-3-3820-7112)
Osaka Electronics Department (TEL +81-6-6244-6672)
 - Cannot be used for PC98-NX series

1.2 Features (When Connected to IE-703002-MC)

- Maximum operating frequency: 20 MHz (at 3.3 to 5.0-V operation)
- Extremely lightweight and compact
- Higher equivalence with target device can be achieved by omitting buffer between signal cables.
- The following pins can be masked.
RESET, NMI, WAIT, HLDRQ
- Two methods of connection to target system:
 - Pod tip direct connection (For information on the pod, refer to the **IE-703002-MC User's Manual (U11595E)**)
 - Attach an extension probe (sold separately) to the pod tip for connection
- The dimensions of the IE-703040-MC-EM1 are as follows.

Parameter		Value
Power consumption (Max. value at 3.3-V supply voltage)		0.35 W (at 20-MHz operation frequency) ^{Note}
External dimensions (Refer to APPENDIX PACKAGE DRAWINGS)	Height	15 mm
	Length	194 mm
	Width	96 mm
Weight		160 g

Note 10.35 W when IE-703002-MC connected to IE-703040-MC-EM1

1.3 Function Specifications (When Connected to IE-703002-MC)

Parameter		Specification	
Emulation memory capacity	Internal ROM	256 Kbytes	
	External memory	In ROM-less mode	2 Mbytes
		When using iROM	1 Mbyte
Coverage memory capacity for execution/pass detection	Internal ROM	256 Kbytes	
	External memory	In ROM-less mode	2 Mbytes
		When using iROM	1 Mbyte
Coverage memory capacity for memory access detection	External memory	1 Mbyte	
Coverage memory capacity for branching entry number counting	Internal ROM	256 Kbytes	
	External memory	In ROM-less mode	2 Mbytes
		When using iROM	1 Mbyte

Caution Some of the functions may not be supported, depending on the debugger used.

1.4 System Configuration

The system configuration when connecting the IE-703002-MC to the IE-703040-MC-EM1 and a personal computer (PC-9800 series or PC/AT™ (or compatibles)) is shown below.

Figure 1-1. System Configuration

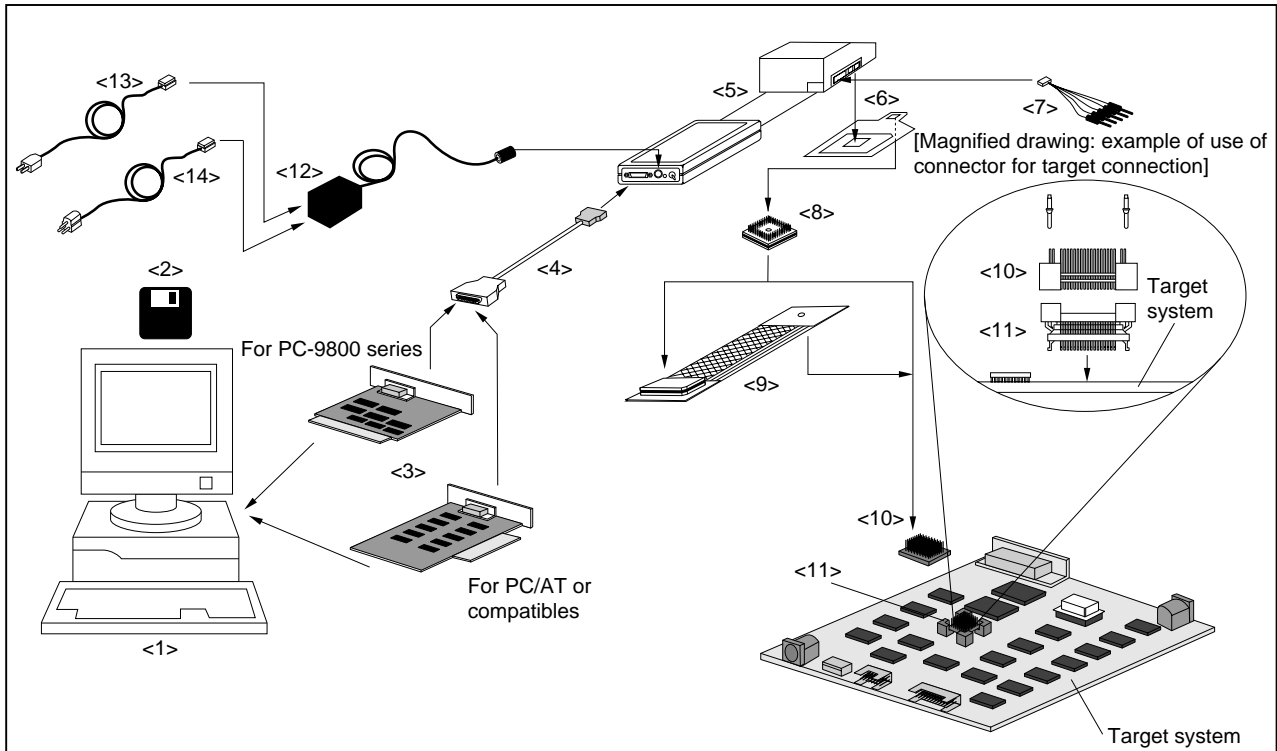

Remark

- <1> Personal computer (PC-9800 series or PC/AT or compatibles)
- <2> Debugger (sold separately)
- <3> PC interface board
(IE-70000-98-IF-B/IE-70000-98-IF-C, IE-70000-PC-IF-B/IE-70000-PC-IF-C: sold separately)
- <4> PC interface cable (included with IE-703002-MC)
- <5> In-circuit emulator (IE-703002-MC: sold separately)
- <6> In-circuit emulator option board (IE-703040-MC-EM1)
- <7> External logic probe (included with IE-703002-MC)
- <8> Socket for target connection (YQSOCKET176SDN: sold separately)
- <9> Extension probe (SC-100SD: sold separately)
- <10> Connector for emulator connection (YQPACK176SD: included)
- <11> Connector for target connection (NQPAC176SD: included)
- <12> Power adapter (IE-70000-MC-PS-B : sold separately)
- <13> AC100-V power cable (sold separately: included with IE-70000-MC-PS-B)
- <14> AC220-V power cable (sold separately: included with IE-70000-MC-PS-B)

1.5 Contents in Carton

The carton of the IE-703040-MC-EM1 contains a main unit, guarantee card, packing list, and accessory bag. Make sure that the accessory bag contains this manual and the connector accessories. If there are missing or damaged items, please contact an NEC sales representative or an NEC distributor.

Figure 1-2. Contents in Carton

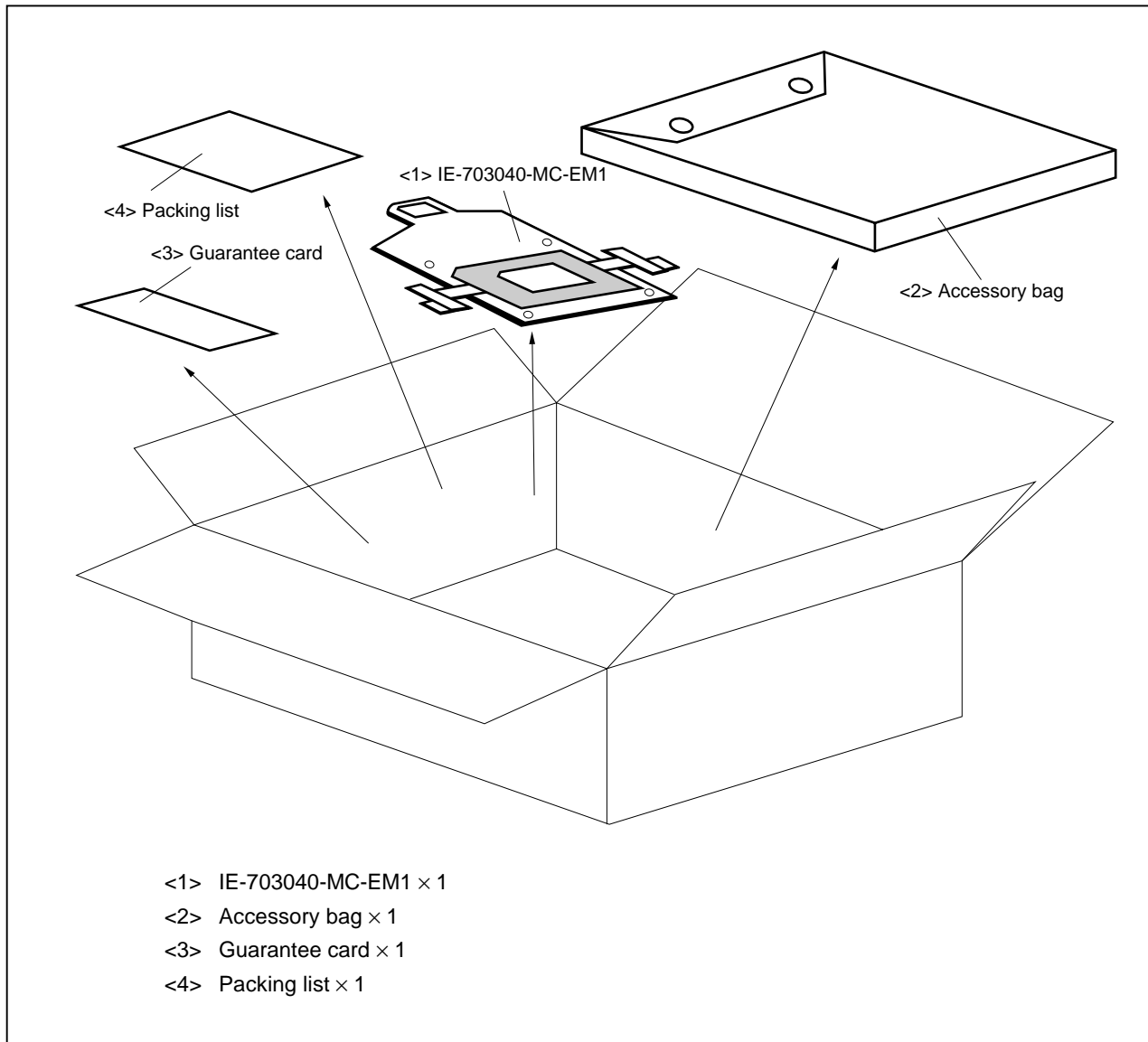

Check that the accessory bag contains this manual, an accessory list (× 1), and the following accessories.

- (a) Connector for target connection (NQPACK176SD) × 1
(including NQGUIDE × 3, driver × 1)
- (b) Connector for emulator connection (YQPACK176SD) × 1
(including YQGUIDE × 4)
- (c) Crystal oscillator (20-MHz, 8-pin type)
- (d) Plastic screws × 4
(including nuts and washer × 4)
- (e) Jumper contact × 1

Figure 1-3. Accessories

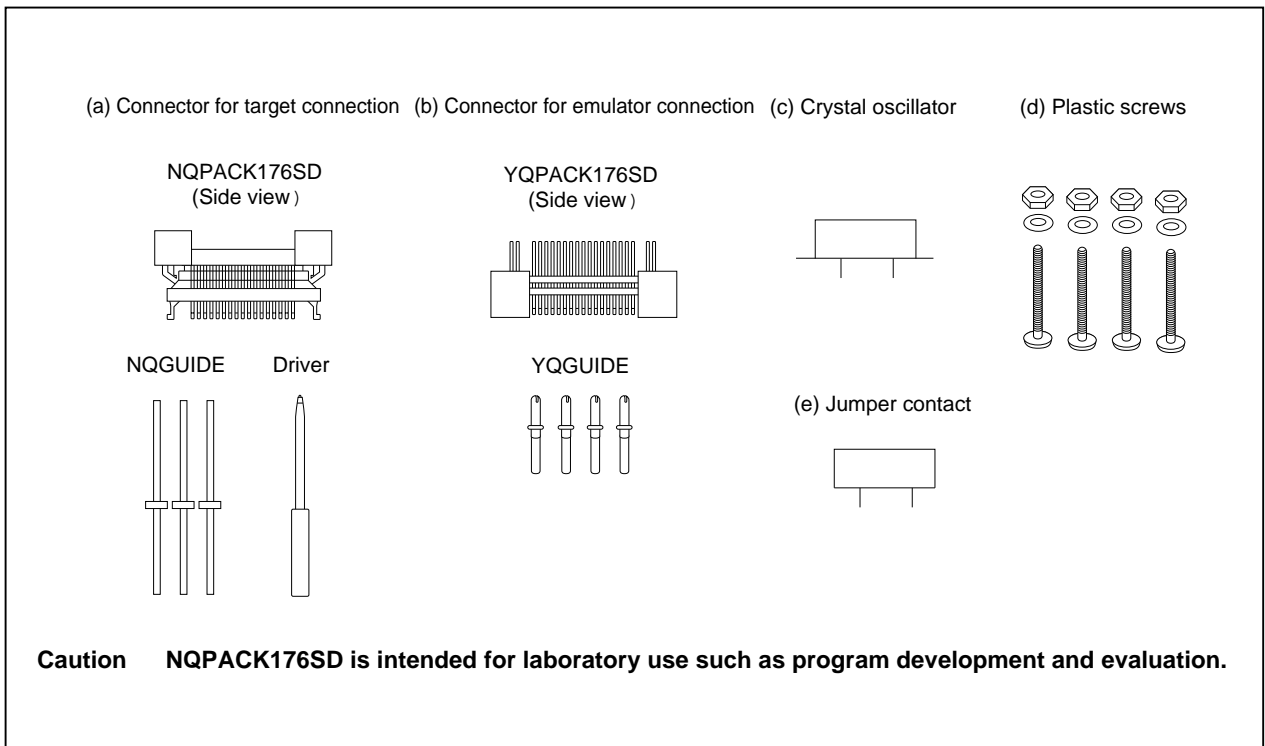

1.6 Connection between IE-703002-MC and IE-703040-MC-EM1

The procedure for connecting the IE-703002-MC and IE-703040-MC-EM1 is described below.

Caution Connect carefully so as not to break or bend connector pins.

- <1> Remove the pod cover (upper and lower) of the IE-703002-MC.
- <2> Replace the crystal oscillator mounted in the pod of the IE-703002-MC with the crystal oscillator supplied (20 MHz) or an arbitrary oscillator (user's frequency).
- <3> Set the PGA socket lever of the IE-703040-MC-EM1 to the OPEN position as shown in Figure 1-4 (b).
- <4> Connect the IE-703040-MC-EM1 to the PGA socket at the back of the IE-703002-MC pod (refer to Figure 1-4 (c)). When connecting, position the IE-703002-MC and IE-703040-MC-EM1 so that they are horizontal.
- <5> Set the PGA socket lever of the IE-703040-MC-EM1 to the CLOSE position as shown in Figure 1-4 (b).
- <6> Set the IE-703002-MC pod jumpers (JP1 to JP4).
 - Open JP1 and JP3 (Remove the jumper contact and attach the removed jumper contact to one of the jumper pins to avoid losing it.)
 - Retain the factory settings of JP2 (pins 1 and 2 shorted, and pins 5 and 6 shorted).
 - Short pins 2 and 3 of JP4.
- <7> Fix the IE-703040-MC-EM1 between the IE-703002-MC pod covers (upper and lower) with the plastic screws (supplied with the IE-703002-MC).
- <8> Fix the IE-703002-MC pod cover (upper) end with nylon rivets.

Remark For the JP1 setting, refer to **2.3 Illegal Access Detection ROM Setting**. For JP3 and JP4, refer to **2.4 CPU Operation Voltage Range Switch Setting**.

Figure 1-4. Connection between IE-703002-MC and IE-703040-MC-EM1 (1/2)

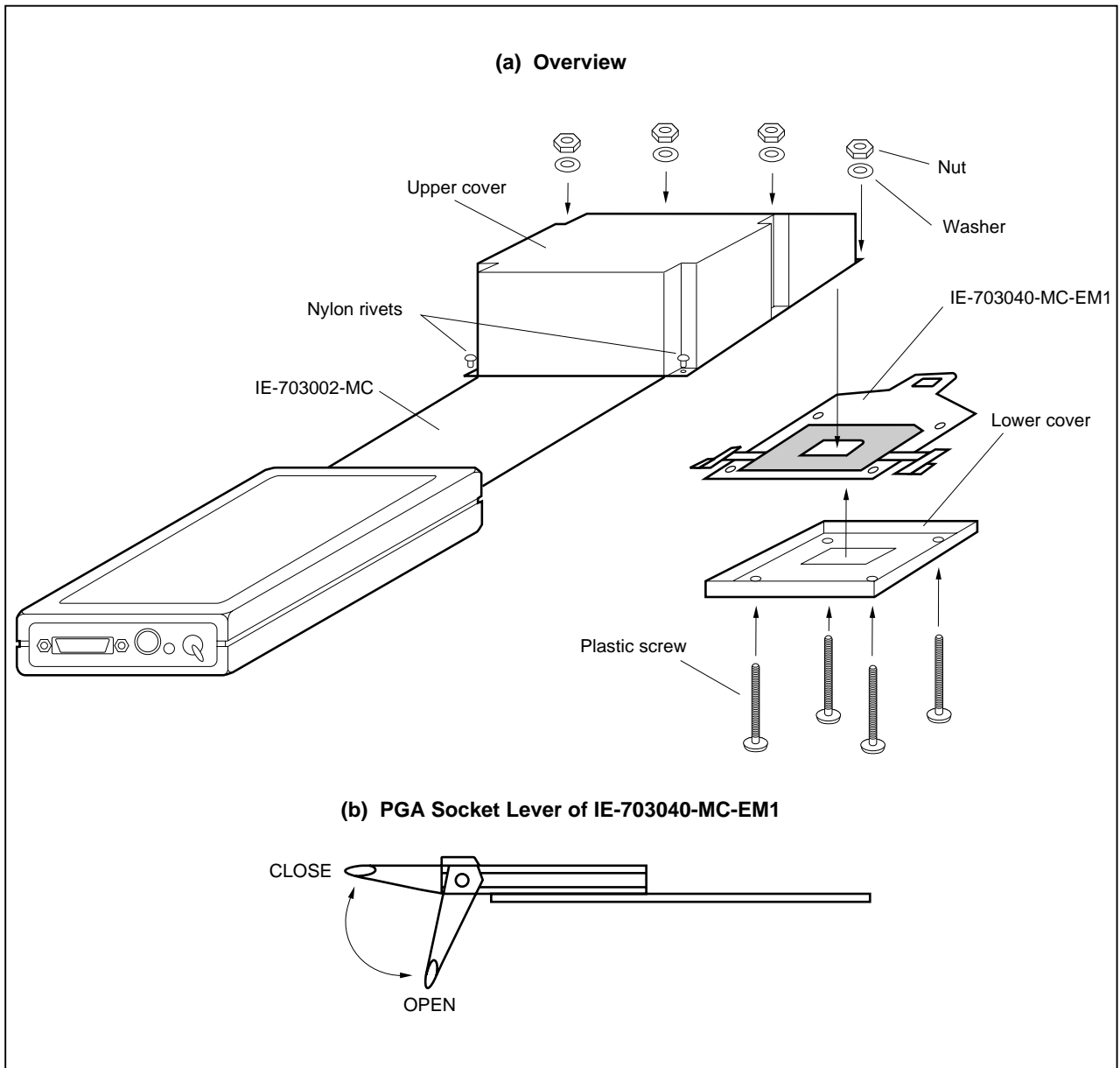
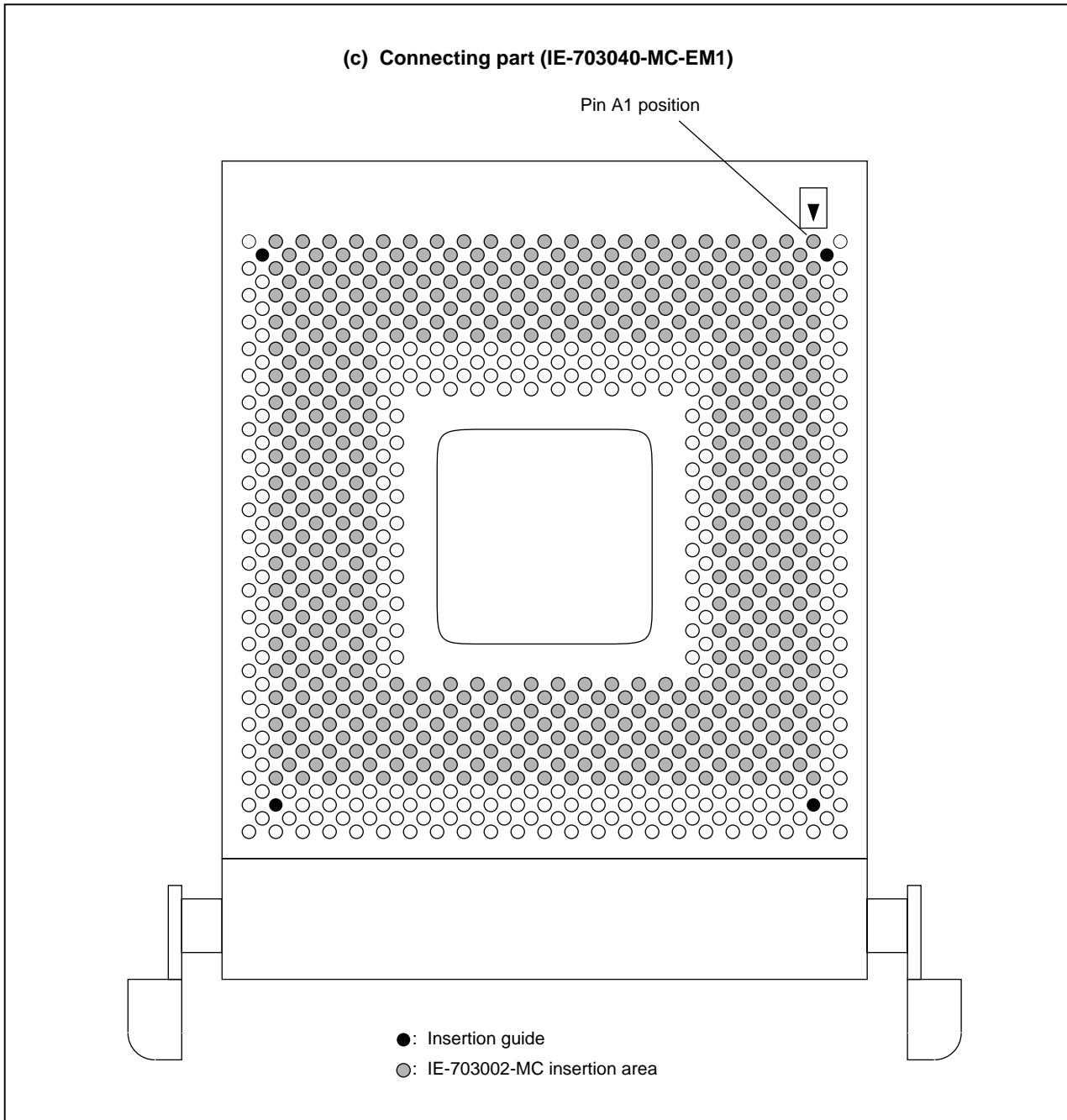

Figure 1-4. Connection between IE-703002-MC and IE-703040-MC-EM1 (2/2)



CHAPTER 2 NAMES AND FUNCTIONS OF COMPONENTS

This chapter describes the names, functions, and switch settings of components in the IE-703040-MC-EM1. For the details of the pod, jumper, and switch positions, etc., refer to the **IE-703002-MC User's Manual (U11595E)**.

2.1 Component Names and Functions of IE-703040-MC-EM1

Figure 2-1. IE-703040-MC-EM1

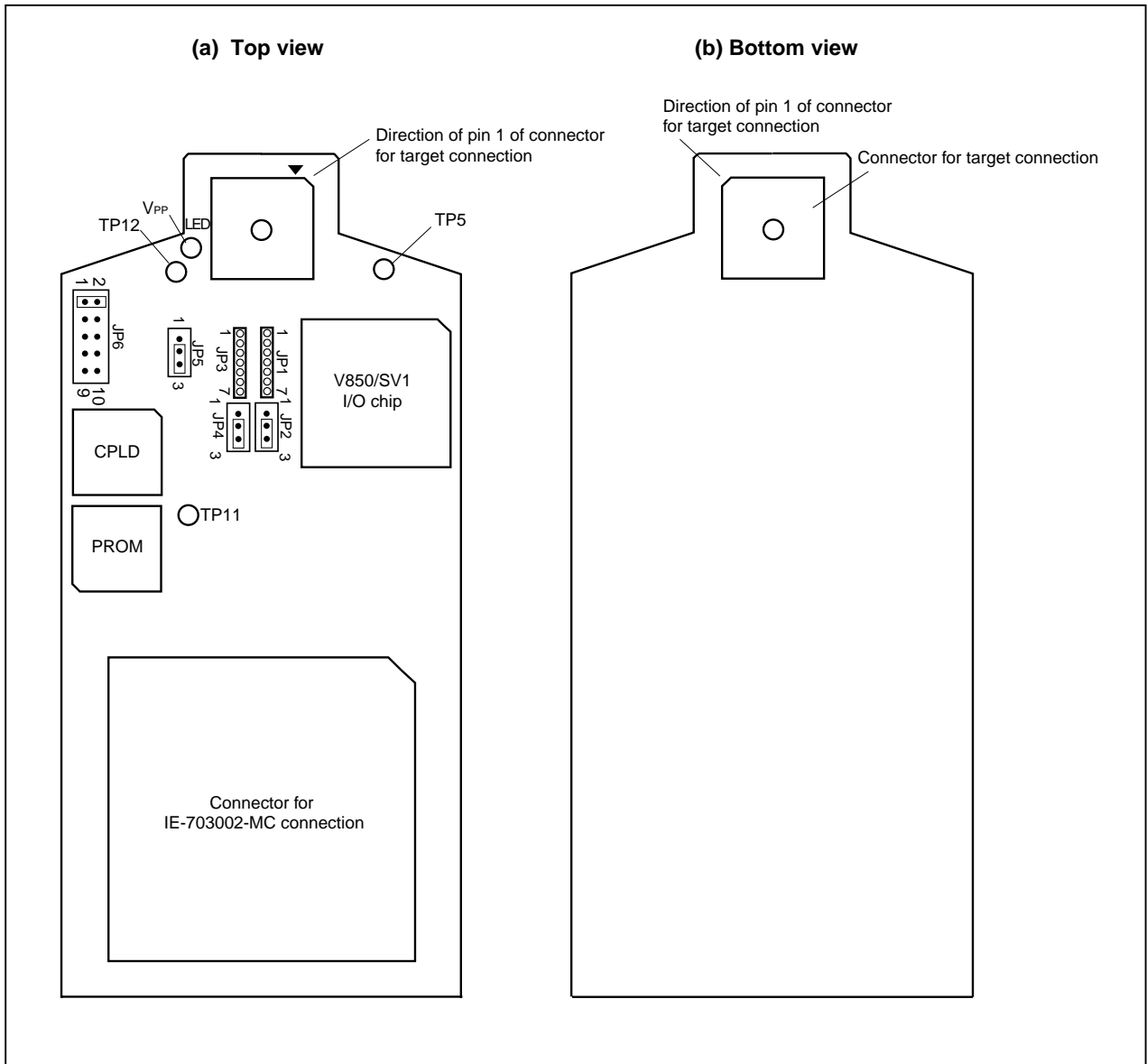

(1) TEST pins (TP5, TP11, TP12)

These are pins used for testing the analog signals of the standalone emulator.

- TP 5: GND
- TP 11: GND
- TP 12: GND

(2) JP1

This is a pin board for product check. Mount nothing on JP1.

(3) JP2, JP4

These are pin boards for product check. Use and retain the factory settings (pins 2 and 3 shorted) (For details, refer to **2.2 Clock Settings**)

(4) JP3

This is a pin board for supplying the subsystem clock. (For details, refer to **2.2 Clock Settings**)

(5) JP5

This is a jumper for switching the main system clock supply source.

(6) JP6

This is a pin board for product check. Use and retain the factory settings (pins 1 and 2 shorted).

(7) LED

LED for V_{PP}

ON: Voltage is applied to V_{PP}

OFF: Voltage is not applied to V_{PP}

(8) Connector for IE-703002-MC connection

This is a connector for connecting with the IE-703002-MC.

(9) Connector for target connection

This is a connector for connecting with the target system or the extension probe.

2.2 Clock Settings

This section describes the clock settings.

For the position of the JP1 and JP2 in the IE-703040-MC-EM1, refer to Figure 2-1.

For the jumper switch position in the IE-703002-MC, refer to the **IE-703002-MC User's Manual (U11595E)**.

2.2.1 Main system clock setting

Table 2-1. Main System Clock Setting

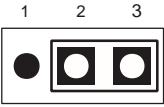
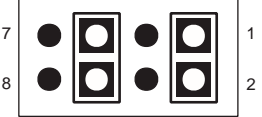
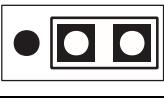
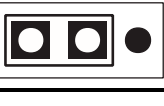
Emulator Use Environment	Clock Supply Method	IE-703040-MC-EM1 Setting	IE-703002-MC Setting		
		JP1	SW1	SW2	JP2
When using emulator as standalone unit	Internal clock		ON	ON	
When using emulator with target system	Internal clock				
	Target clock ^{Note}				

Note The target clock supports only an oscillator (X2 cannot be used because it is not connected in the emulator).

Clock input by resonator is not supported.

2.2.2 Subsystem clock setting

Table 2-2. Subsystem Clock Setting

Emulator Use Environment	Clock Supply Method	IE-703040-MC-EM1 Setting
		JP3
When using emulator as standalone unit	Internal clock ^{Note 1}	Oscillator mounted (a 32.768-kHz oscillator is mounted when shipped) ^{Note 3}
When using emulator with target system	Internal clock ^{Note 1}	Oscillator mounted (a 32.768-kHz oscillator is mounted when shipped) ^{Note 3}
	Target clock ^{Note 2}	Pins 3 and 4 of JP3 are shorted ^{Note 4}

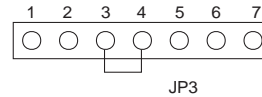

- Notes**
1. The internal clock does not support the clock input by an oscillator.
 2. The target clock supports only an oscillator (XT2 cannot be used because it is not connected in the emulator).
Clock input by oscillator is not supported.
 3. To use a subsystem clock frequency other than 32.768 kHz, remove the clock module on JP3 and mount any oscillator.
The specifications of JP3 are as follows.

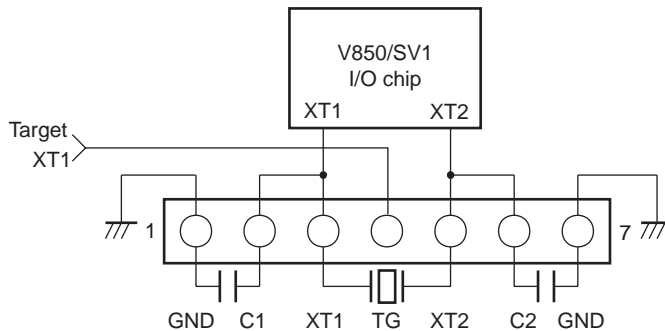

4. Prepare the short pin.

2.3 Illegal Access Detection ROM Setting

If using the IE-703002-MC for an in-circuit emulator for the V850/SV1 by connecting the IE-703040-MC-EM1, set JP1 of the IE-703002-MC as follows.

Table 2-3. JP1 Setting in IE-703002-MC

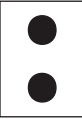
JP1		Description
Open ^{Note}		Illegal access detection ROM (mounted on IE-703040-MC-EM1) for V850/SV1 is used.

Note When JP1 is set open, keep the removed jumper contact attached to one pin as shown in the drawing on the right.

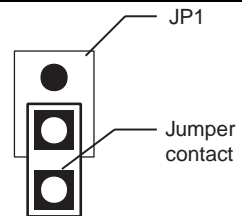

2.4 CPU Operation Voltage Range Switching Setting

If using the IE-703002-MC for an in-circuit emulator for the V850/SV1 by connecting the IE-703040-MC-EM1, set JP3 and JP4 of the IE-703002-MC as follows.

Table 2-4. JP3 and JP4 Setting in IE-703002-MC

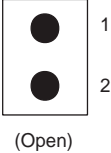
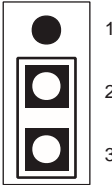
JP3, JP4		Description
JP3	 (Open)	The operation voltage range of the IE-703002-MC is to 2 to 3.6 V
JP4		The operation voltage range of the target system is 2 to 4.5 V. (Use this setting since the operation voltage range of the V850/SV1 is 2 to 3.6 V.)

Caution By settings of JP3, JP4 above, when the power supply of the target system is on, the IE-703002-MC operates at the same voltage as the target system.
The IE-703002-MC always operates at 3.3 V when the power supply of the target system is off and using emulator as standalone unit.

[MEMO]

CHAPTER 3 FACTORY SETTINGS

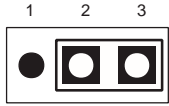
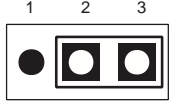
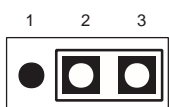
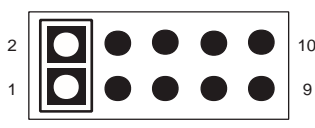
Item	Description	Remark
JP1	Oscillator not mounted	Pin board for product check
JP2		Jumper switch for product check
JP3	Oscillator mounted	32.768-kHz clock supplied for subsystem clock
JP4		Jumper switch for product check
JP5		Internal clock used for main system clock
JP6		Jumper switch for product check

[MEMO]

CHAPTER 4 CAUTIONS

4.1 V_{DD} and BV_{DD} of Target System

- (1) BV_{DD} in the target system is not connected to BV_{DD} in the evaluation chip in the IE-703002-MC.
The IE-703002-MC uses BV_{DD} of the target system for the following purposes:
 - Power ON/OFF detection of target system
 - BV_{DD} emulation of target system
- (2) When the voltage of the target system is 1 V or higher, the evaluation chip in the emulator operates using the supply of V_{DD} from the target system. The power consumption is equivalent to that of the V850/SV1.
- (3) When the voltage of the target system is lower than 1 V, the emulator recognizes the target system power is off and operates at 3.3 V.

Figure 4-1. Schematic Diagram of Power Supply Acquisition

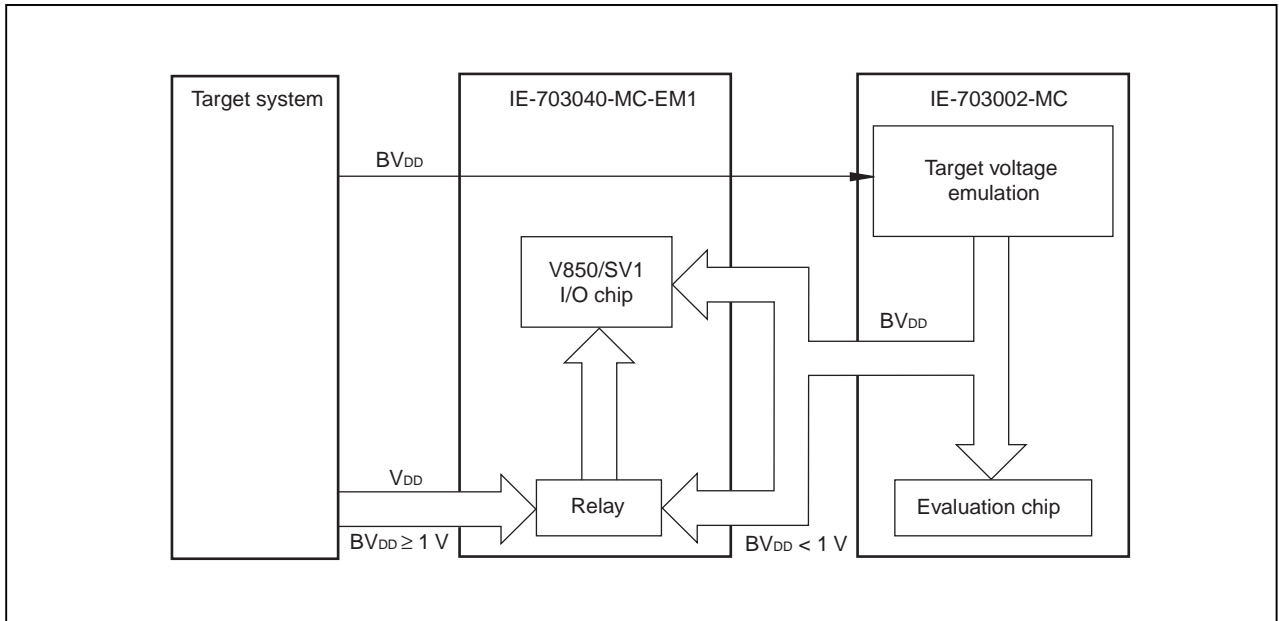

4.2 NMI Signal

The input signal (NMI signal) from the target system is delayed ($t_{pD} = 0.25$ ns (TYP.)) because it passes through QS3125 (Q switch) before it is input to the I/O chip of the emulator.

In addition, the DC characteristics change. The input voltage becomes $V_{IH} = 2.0$ V (MIN.), $V_{IL} = 0.8$ V (MAX.), and the input current becomes $I_{IN} = \pm 0.5$ μ A (MAX.).

Figure 4-2. NMI Signal Flow Path

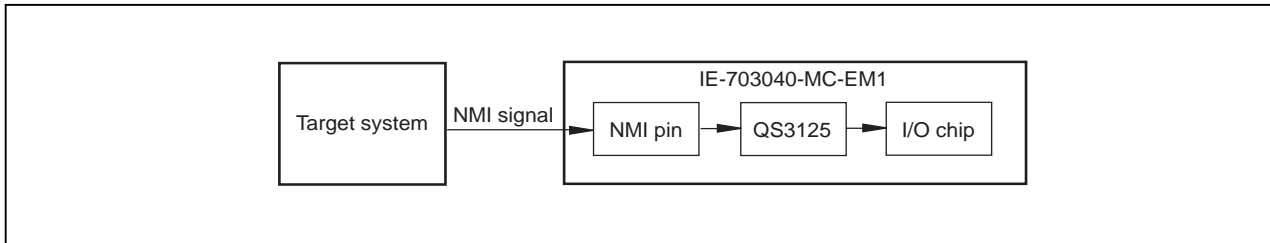

4.3 V_{PP} Signal

The V_{PP} signal from the target system is connected to LED via a 330- Ω resistor in the emulator. It is not connected to the evaluation chip in the emulator.

Figure 4-3. V_{PP} Signal Flow Path

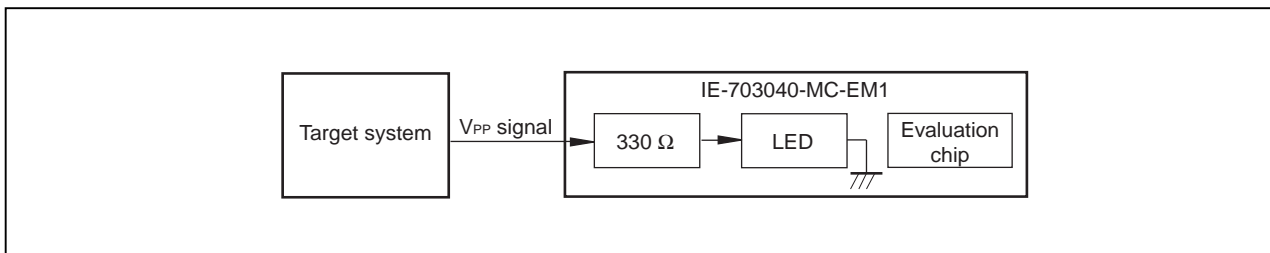

4.4 NMI Signal Mask Function

When using the P00/NMI pin in the port mode, do not mask the NMI signal.

4.5 Bus Interface Pin

The operation of the pin for the bus interface differs between the emulator and the target device as follows.

Table 4-1. Bus Interface Pin Operation List (1/2)
(a) During break

Pin Name	Internal Memory							External Memory				
	Memory Used by Emulator			Internal ROM	Internal RAM		Internal Peripheral I/O		Emulation RAM		Target System	
	F	R	W	R	R	W	R	W	R	W	R	W
A16 to A21	Hold the last accessed address							Active		Active		
AD0 to AD15	Hi-Z							Active		Active		
ASTB	H							Active		Active		
$\overline{R/W}$	H							Active		Active		
\overline{DSTB}	H							H		Active		
\overline{LBEN}	H							Active		Active		
\overline{UBEN}	H							Active		Active		
\overline{WAIT}	Invalid							Maskable		Maskable		
\overline{HLDRQ}	Maskable							Maskable		Maskable		
\overline{HLDAK}	H or L							H or L		H or L		
\overline{WRL}	H							H		H	Note	
\overline{WRH}	H							H		H	Note	
\overline{RD}	H							H		Note	H	

Note Active

- Remarks**
1. F: Fetch
R: Read
W: Write
 2. H: High-level output
L: Low-level output
Hi-Z: High-impedance

Table 4-1. Bus Interface Pin Operation List (2/2)
(b) During run

Pin Name	Internal Memory							External Memory					
	Internal ROM		Internal RAM			Internal Peripheral I/O		Emulation RAM			Target System		
	F	R	F	R	W	R	W	F	R	W	F	R	W
A16 to A21	Hold the last accessed address							Active			Active		
AD0 to AD15	Hi-Z							Active			Active		
ASTB	H							Active			Active		
$\overline{R/W}$	H							Active			Active		
\overline{DSTB}	H							H			Active		
\overline{LBEN}	H							Active			Active		
\overline{UBEN}	H							Active			Active		
\overline{WAIT}	Invalid							Maskable			Maskable		
\overline{HLDRQ}	Maskable							Maskable			Maskable		
\overline{HLDAK}	H or L							H or L			H or L		
\overline{WRL}	H							H			H		Note
\overline{WRH}	H							H			H		Note
\overline{RD}	H							H			Note		H

Note Active

- Remarks**
1. F: Fetch
R: Read
W: Write
 2. H: High-level output
L: Low-level output
Hi-Z: High-impedance

APPENDIX PACKAGE DRAWINGS

IE-703002-MC + IE-703040-MC-EM1 (Unit: mm)

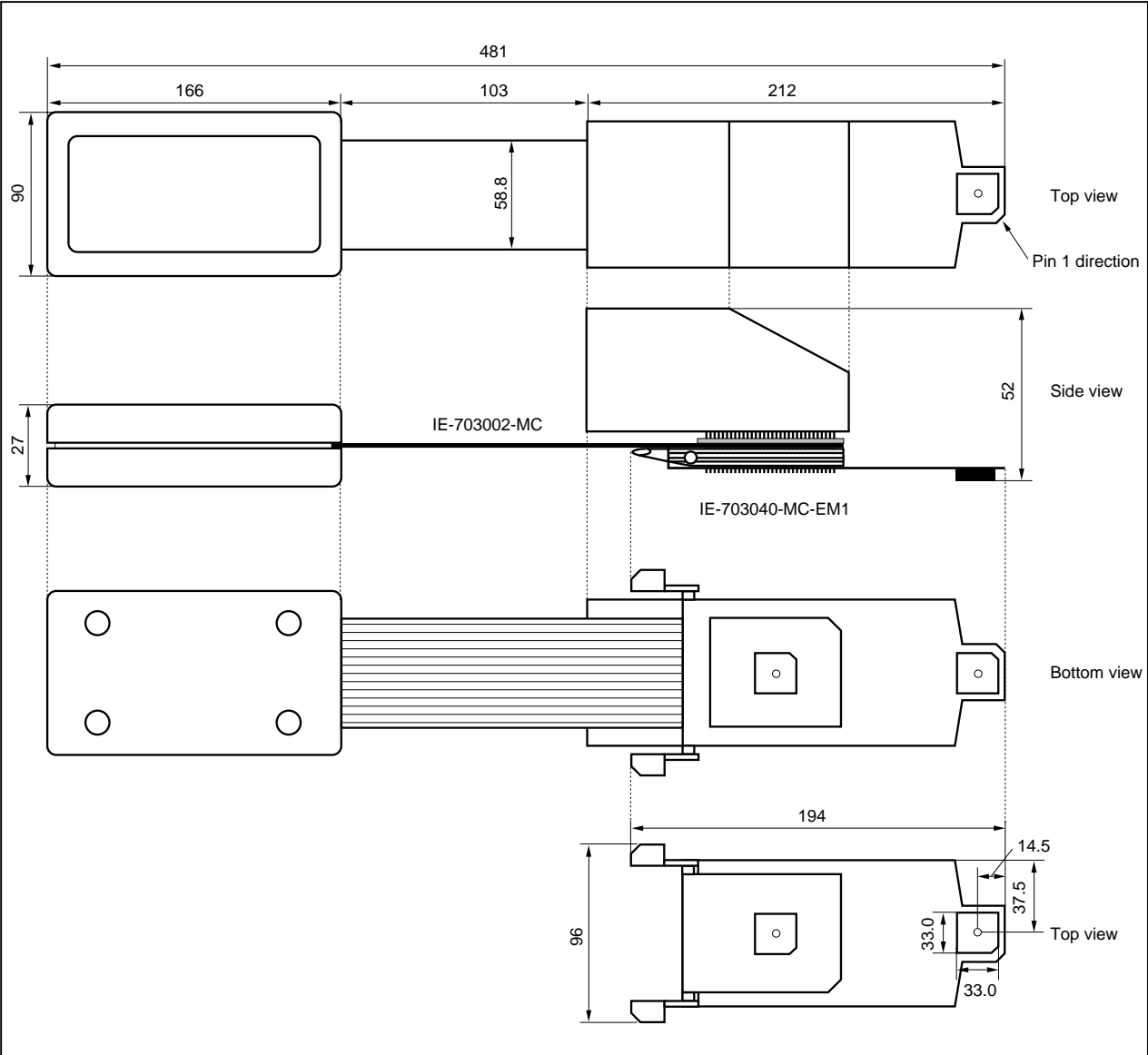

[MEMO]

[MEMO]

[MEMO]

Facsimile Message

Although NEC has taken all possible steps to ensure that the documentation supplied to our customers is complete, bug free and up-to-date, we readily accept that errors may occur. Despite all the care and precautions we've taken, you may encounter problems in the documentation. Please complete this form whenever you'd like to report errors or suggest improvements to us.

From:

Name

Company

Tel.

FAX

Address

Thank you for your kind support.

North America

NEC Electronics Inc.
Corporate Communications Dept.
Fax: 1-800-729-9288
1-408-588-6130

Hong Kong, Philippines, Oceania

NEC Electronics Hong Kong Ltd.
Fax: +852-2886-9022/9044

Asian Nations except Philippines

NEC Electronics Singapore Pte. Ltd.
Fax: +65-250-3583

Europe

NEC Electronics (Europe) GmbH
Technical Documentation Dept.
Fax: +49-211-6503-274

Korea

NEC Electronics Hong Kong Ltd.
Seoul Branch
Fax: 02-528-4411

Japan

NEC Semiconductor Technical Hotline
Fax: 044-548-7900

South America

NEC do Brasil S.A.
Fax: +55-11-6465-6829

Taiwan

NEC Electronics Taiwan Ltd.
Fax: 02-2719-5951

I would like to report the following error/make the following suggestion:

Document title: _____

Document number: _____ Page number: _____

If possible, please fax the referenced page or drawing.

Document Rating	Excellent	Good	Acceptable	Poor
Clarity	<input type="checkbox"/>	<input type="checkbox"/>	<input type="checkbox"/>	<input type="checkbox"/>
Technical Accuracy	<input type="checkbox"/>	<input type="checkbox"/>	<input type="checkbox"/>	<input type="checkbox"/>
Organization	<input type="checkbox"/>	<input type="checkbox"/>	<input type="checkbox"/>	<input type="checkbox"/>